Infrared Moisture Determination Balance
FD-610

Operating Manual

Infrared Moisture Determination Balance Safety Notes

Improper use of the infrared moisture tester in violation of the following safety notes may result in death, injury or damage to property due to fire, etc. Furthermore, the infrared moisture tester has high temperature components which can cause burns if proper safety guidelines are not followed.



- **Observe all safety guidelines**

Carefully read and observe all safety notes included in this user's manual.

- **Do not use the unit if it appears to be malfunctioning**

If you suspect a problem or malfunction in the unit, discontinue use and immediately have the unit inspected by certified Kett service personnel.

- **Meanings of Warning Indicators and Symbols**

 Warning	Failure to observe these items may lead to death or injury to the user.
 Caution	Failure to observe these items may lead to injury to the user or damage to property.
 Note	Items which the user should be aware of in order to use the unit safely.

Caution Symbols



Fire Hazard



Burn Hazard



Electric Shock Hazard

Prohibition Symbols



Prohibited



Do Not Disassemble



Do Not Expose to Water

Symbols Requiring User Action



Required Action



Disconnect Plug from Electrical Outlet







Warning



Fire Hazard



Electric Shock Hazard

-  Do not attempt to measure samples which may undergo dangerous chemical reactions when heated as doing so may result in explosion or release of toxic gas.
-  Do not place flammable materials near the infrared moisture tester. Some parts of the infrared moisture tester become extremely hot during operation and could lead to fire if flammable materials are placed nearby. Application of excessively high voltage may result in overheating to malfunction or fire.
-  Be sure to turn off the unit's power supply before attempting to replace the infrared lamp. Electric shock may result if your finger or metal objects are inserted into the socket.
-  Do not attempt to disassembly, modify or rebuild the infrared moisture tester. Doing so may result in accident, electric shock, etc. If you believe the unit may be malfunctioning take it to an authorized Kett service center for service.
-  Do not allow the unit to come in contact with water. The infrared moisture tester is not waterproof. Do not allow water or other liquids to get into the unit's enclosure as this may lead to electric shock or malfunction.



Caution



Burn Hazard



Electric Shock Hazard

-  Do not touch the lamp cover or sample dish with your bare hands. Doing so may result in burns. The infrared moisture tester is at high temperature during and immediately after making measurements, When touching the unit, only use the specified control knobs and accessories.

Contents

1. Description of Features and Principles of Operation	7
2. Specifications.....	8
3. Part Names.....	10
4. Display and Control.....	12
5. Assembly and Installation of Main Unit.....	14
6. Setting and Changing Measurement Parameters.....	18
7. Making Measurements.....	22
8. Notes Regarding Measurement.....	26
9. RS-232C Output	28
10. Notes Regarding Use of the FD-610.....	30
11. Maintenance	31
Appendix : Representative Drying Example	32

1. Description of Features and Principles of Operation

The Kett Model FD-610 Infrared Moisture Balance determines the moisture and solid component(%) content of samples by using infrared light to heat and dry samples and then measuring weight changes due to evaporation.

Special Characteristics of the FD-610

- (1) The FD-610 can display either the moisture or solid component content of samples.
- (2) Samples of any weight between 5 and 70g are allowed and the ease of use makes it possible for anyone to make accurate measurements.
- (3) The FD-610 incorporates an automatic tare system which raises and lowers the sample dish, thereby continually performing zero point compensation to make more precise measurements possible. (Patent pending.)
- (4) The drying temperature is automatically controlled to maintain the set value.
- (5) The FD-610 features 2 types (A and B) of Auto Measurement Modes in which the unit stops automatically when the constant quantity value is reached.
- (6) A printer (optional) can be connected to print out hard copies of data such as the drying status during the measurement and the final measurement value, etc.

Measurement Samples

The FD-610 can be used to measure the moisture content of samples of any material in which the moisture content can be evaporated by heating.

However, never use the FD-610 to measure samples of materials which may undergo dangerous chemical reactions (explode or give off poisonous gases, etc.) when heated. Furthermore, various parts of the FD-610 are made of composite resins. Avoid using the FD-610 with samples which may cause chemical decomposition of these parts or samples which may give off gases which could cause such damage.

2. Specifications

Measurement method	: Detection of weight loss by heating & drying
Sample Weight	: 5 ~ 70g optional weight sampling format
Minimum Moisture Content Displayed	: 0.1%
Minimum Displayed Weight	: 5mg
Information Displayed	: Moisture, solid component (0.0 ~ 100%) Weight (0.00 ~ 69.995g) ("WEIGHT CHECK" is displayed when sample weight is 70g or more) Temperature (0 ~ 200°C)
Precision	: $\pm 0.1\%$ (5g or more)
Measurement Mode	: Time Measurement Mode (1 ~ 90 minutes), Auto Measurement Mode (A or B)
Drying Time Setting Range	: 1 ~ 90 minutes (Key input, 1 minute increments, with memory) *Drying stops automatically after 90 minutes in the Auto Measurement Mode for safety reasons.
Drying Temperature Setting Range	: 65 ~ 195°C (Key input, 1°C increments, with memory)
Drying Completion Point Detection Method	: Moisture (solid component) fluctuation monitoring method
Display Format	: Digital LCD display
External output	: RS-232C interface
Environmental conditions	: Temperature 5 ~ 40°C, Humidity 85% or less
Sample Dish	: SUS manufactured ($\varnothing 95$ mm, depth 10mm)

Heat Source : 185W Infrared bulb x 1pce

Temperature Measurement Method : Thermistor

Power Supply : AC 100 ~ 120V / 220 ~ 240V (50 / 60 Hz)

Power Consumption : Maximum 185W (lamp) + 2W (control section)

External Dimensions & Weight : 210 (W) x 320 (D) x 318 (H) mm, 3.0kg

Auto Tare Function : Automatic tare at 30 second intervals

Accessories : Infrared lamp 185W (2 pcs), Sample dish (2 pcs), Sample dish stand, Wind shield, 0.5A Fuse, Power supply cord, Aluminum sheets (20 pcs), Spoon set, Pincet, Dust cover, Operating manual

Options : Printer set (VZ-330, Printer connection cable VZC-14, Printer paper, AC adapter)
Printer paper (10 roll), Aluminum sheets (500 pcs), Grain Crusher TQ-100
Data Logger Software (KDL-01)

3. Part Names

1. Main Unit External Appearance

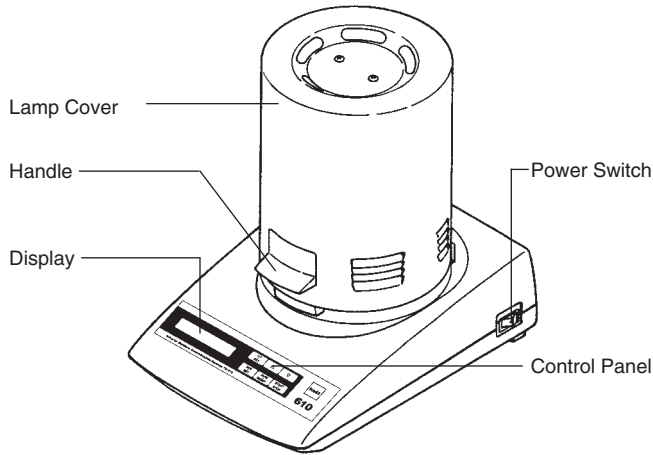

2. The Rear Panel

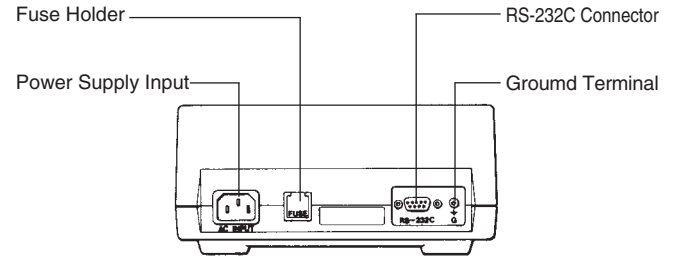

- In Japan, use the FD-610 with a 100V power supply. The lamp will be damaged if the unit is supplied with 220V when an infrared lamp with a 100V rating is installed in the tester.

3. Accessories

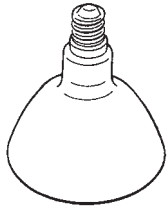

Infrared lamp 185W (2 pcs)



Sample dish (2 pcs)



Sample dish stand

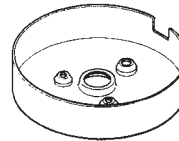

Wind shield



0.5A Fuse

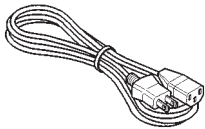

Power supply cord

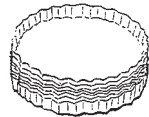

Aluminum sheets (20 pcs)

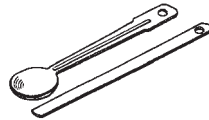

Spoon set



Pincet



Dust cover

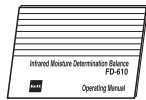

Operating manual



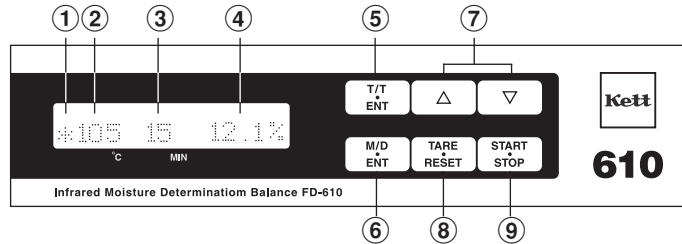







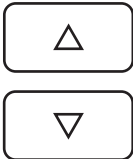

4. Display and Control



1. The Display

Item	Name	Description
①	Drying Stop Indicator	This indicator appears when the drying operation stops.
②	Temperature Display Indicator	This indicator displays the set drying temperature or the temperature during the drying operation when measurements are being made. The indicator displays values between 0 and 200 °C.
③	Time Display Indicator	<ul style="list-style-type: none"> In the Time Measurement Mode Displays the set time (1 ~ 90 minutes) when measurements are started and then displays the time remaining while measurements are being made. Auto Measurement Mode When the set time value exceeds 90, "A" and then "B" are displayed to indicate that the unit is in the Auto Measurement Mode. The elapsed time is displayed with a plus ("+") sign while measurements are being made. * When "00" is inputted, the elapsed time is displayed with a plus ("+") sign while measurements are being made.
④	Moisture Content and Weight Display Indicator	Displays the sample weight (in grams) before measurements are started and displays the moisture or solid component content while measurements are being made. Measurements are made at 30 second intervals and a  mark blinks in place of the percentage mark ("%") while the sample dish is being raised or lowered.

2. Control Panel Functions

Item	Name	Operation
⑤	 Temperature / Time, Enter Key	This key is used to input and set (input confirmation) the drying temperature and drying time.
⑥	 M/D • Enter Key	This key is used to switch between and set the moisture display and solid component display.
⑦	 Up and Down Key	<p>These keys are used to make changes when setting the drying temperature and drying time.</p> <p> ... Increases value in increments of one</p> <p> ... Decreases value in increments of one</p> <p>Holding down these keys increases or decreases the value continuously.</p> <p>These keys can be used to change the display to the moisture content or solid component content.</p> <p> ... Display switches to moisture content</p> <p> ... Display switches to the solid component content</p>
⑧	 TARE • RESET Key	This key is used for zero point adjustment and tare weight deletion, and is also used to reset the unit. When the  key is pressed, "BUSY" is displayed while the sample dish is raised or lowered and then "0.000g" is displayed.
⑨	 START • STOP Key	<p>This key is used to start and stop measurements. When the  key is pressed the lamp lights, the display switches from the weight (g) display to the moisture content (%) display and measurement begins. Drying can be stopped at any time while the measurement operation is in progress by pressing the  key. To resume measurements after stopping, press the  key to move to the next operation.</p>

5. Assembly and Installation of Main Unit

- ① Open the package and check to make sure all listed items are included.

- ② Set up the unit on a flat, stable surface where it will not be affected by external vibrations or wind, etc.

- ③ Check power supply voltage.
Only use an infrared lamp which is compatible with the power supply voltage being used. (See page 30.)

④ Installing the lamp

Push up on the handle on the drying section and the entire drying section will tilt back and open. While making sure that it does not close again, push the thermistor a little to the side and then screw the infrared lamp in completely while holding the thermistor out of the way.

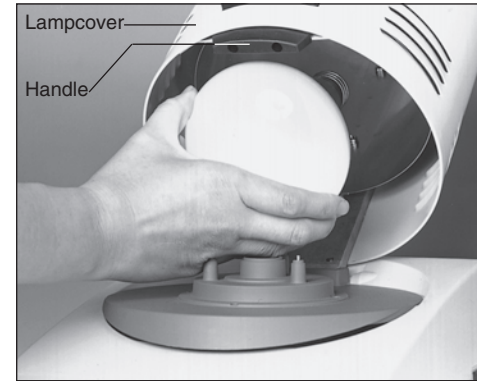
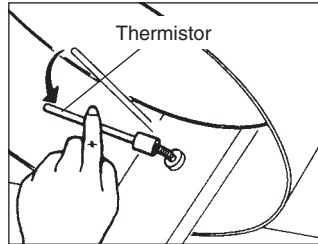

⑤ Slowly release the thermistor. The spring will return the thermistor to its original position, but be careful not to release it too suddenly as doing so may damage the infrared lamp. If the thermistor does not return to its original position, move it back to the original position with your finger.

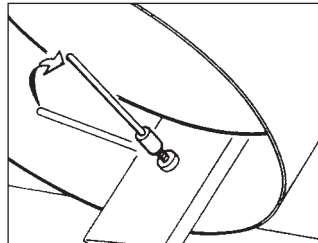

⑥ Attach the wind shield

Set the wind shield in place so that the triangular mark (“△”) is facing the front of the unit.

When set correctly the three receiving holes on the wind shield will match up with the three supports on the main unit.

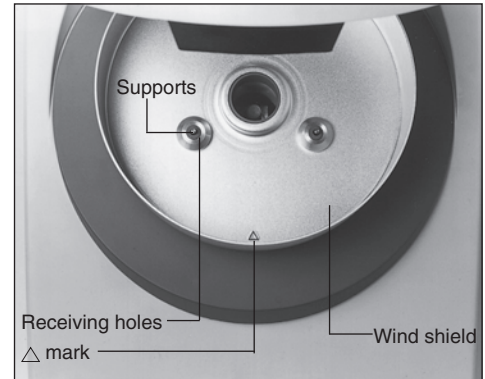

⑦ Set the sample dish stand in place.

Set the sample dish so that its triangular mark (“▽”) matches that on the wind shield (“△”) and then gently insert its support into the hole in the center of the wind shield.

When set in place correctly the sample dish stand will be rigid and will not rotate.

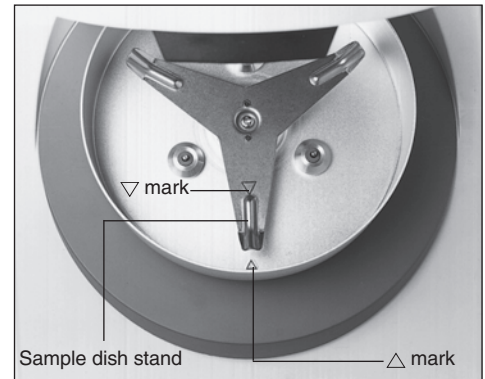

⑧ Set the sample dish in place.

Use the pincet to place the sample dish on the sample dish stand. Next, grasp the lampcover handle and gently close the drying section. Always be sure to grasp the handle when opening and closing the lampcover.



Caution

* Always be sure to grasp the handle when opening and closing the lampcover.

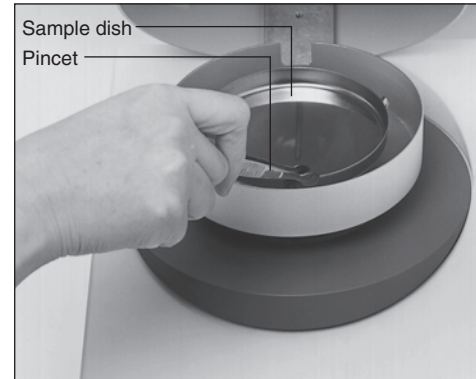

⑨ Connect the power supply cord to the power supply input on the rear panel and then connect it to 100~120V / 220~240V AC electrical outlet.

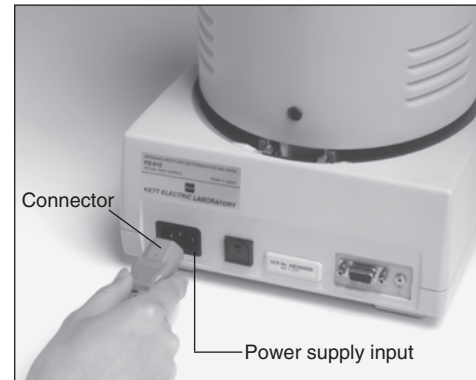

6. Setting and Changing Measurement Parameters

The FD-610's display (%) standard, drying temperature, drying time and measurement mode parameters can be set as necessary.

Please be sure to input the desired settings beforehand.

Parameter settings can be changed using the same procedure that is used to set them originally. The settings are maintained in the unit's memory until the operations indicated below are performed, therefore it is not necessary to make new settings each time the unit is used.

1. Parameters and Parameter Ranges

Parameter	Parameter Range
Display (%) Standard	Moisture content (Wet base), Solid component content
Drying Temperature	65 ~ 195°C (in 1°C increments)
Drying Time	1 ~ 90 minutes (in 1 minute increments)
Measurement Mode	Time Measurement, Auto Measurement

2. Display (%) Standard Setting

It is possible to set the display standard to moisture content (wet base) or solid component content.

- * The FD-610 is initially set to Moisture Content when shipped from the factory.







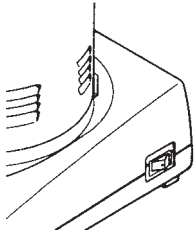
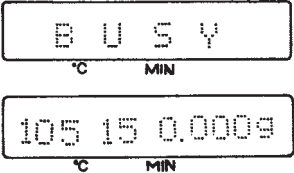
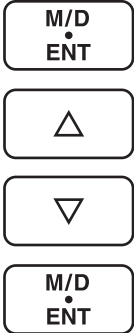

$$\text{Moisture Content (\%)} : \text{MOIST} = \frac{W - W_0}{W} \times 100\%$$

$$\text{Solid Component (\%)} : \text{DRY.M} = (100 - \text{MOIST}) \%$$

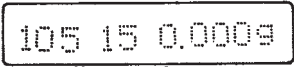
W : Initial sample weight

W₀ : Absolute dry weight

Display (%) Standard Setting Procedure

Main Unit Key Operations	Display	Explanation of Operations
<p>① Turn the Power On</p> 		<p>1. "BUSY" appears in the display when the power switch on the right side of the unit is turned on and the sample dish is raised or lowered to automatically adjust to the scale's zero point. When the zero adjustment has been completed the temperature, time and weight are displayed. (The settings are as indicated in the display diagram to the left when the units are shipped from the factory.)</p>
<p>② Set the Display (%) Standard</p> 	 <p>▲ : MOIST The moisture content is displayed.</p> <p>▼ : DRY. M The solid component content is displayed.</p> 	<p>2. The message shown in the display diagram on the left is displayed when the  key is pressed.</p> <p>When either the  key or  key is pressed a  mark blinks at the up ("▲") or down ("▼") mark corresponding to the key pressed.</p> <p>3. Press the  key a second time to enter the setting.</p>

3. Drying Temperature Setting and Time Setting

In order to measure the moisture content (%) of a sample it is necessary to set a drying temperature and drying time (in the Time Measurement Mode) that is appropriate for the material being measured. Alternatively, to make measurements without specifying a drying time, the Time parameter can be set to “00” or to “A” or “B” to select the Auto Measurement Mode so that measurements are completed automatically.

• The Auto Measurement Mode

When the Time parameter is set to a value exceeding 90 when the time setting is made, the display switches to “A” and then “B” and the unit is set to the Auto Measurement Mode.







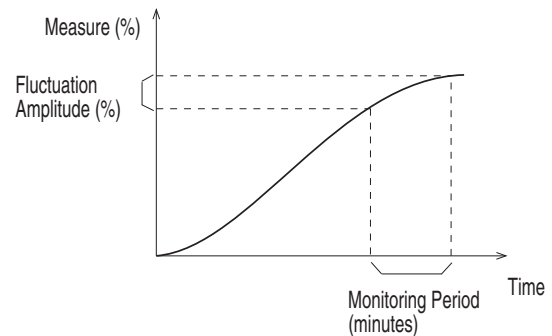







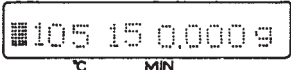





In the Auto Measurement Mode The FD-610 judges that drying has been completed when moisture content fluctuations drop to 0.1% or less during the monitoring period and the unit then stops the drying process and sounds a buzzer to alert the user. There are two different monitoring time and fluctuation amplitude settings, called the A and B settings. Select the setting which is most appropriate for the sample being measured.

Fluctuation Amplitude and Monitoring Period Settings in the Auto Measurement Mode

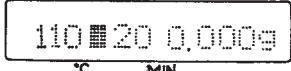
Setting	Fluctuation Amplitude (%)	Monitoring Period (minutes)
A	0.1	1
B	0.1	2



Drying Temperature • Time Setting Procedure

Main Unit Key Operations	Display	Explanation of Operations
<p>① Drying Temperature Setting</p>    	 	<ol style="list-style-type: none"> 1. Press the  key. A rectangular indicator will blink in front of the temperature section on the display. The temperature can be set when the unit is in this state. 2. Press the  or  key to set the display to the desired temperature (numerical value). (The displayed value changes continuously when the keys are held down.) 3. Press the  key a second time when the desired temperature setting value is displayed. The rectangular indicator in front of the temperature section will disappear. (The temperature setting has been entered.)
<p>② Drying Time Setting</p>   	  	<ol style="list-style-type: none"> 4. Now the  mark blinks in front of the time section on the display. The time setting can be made when the unit is in this state. 5. Press the  or  key to set the display to the desired time (numerical value or A or B). 6. Press the  key when the desired time setting is displayed. The  mark will disappear and the time setting is entered.



7. Making Measurements





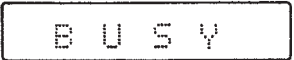
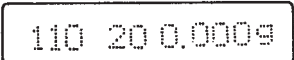

This section describes procedures used after completing the settings described in section 6., Setting and Changing Measurement Parameters, beginning on page 18.



If the power has been turned off since the settings were made, turn the power on again and then follow the measurement procedures described below after confirming that the various setting values are correct.

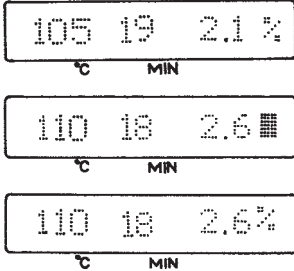

- If the FD-610 unit is being used for the first time, be sure to make the parameter settings described in Section 6 beginning on page 12.
- The following explanations are based upon an example case in which the drying temperature is 110°C, the drying time is set to 20 minutes in the Time Measurement Mode and the sample weight is 8.210 grams.

Measurement Procedure

Main Unit Key Operations	Display	Explanation of Operations
① Zero Point Adjustment Tare weight elimination 	 	Close the lamp cover (drying section) and then press the  key without placing anything on the sample dish. The sample dish will be raised or lowered, “BUSY” will appear on the display for several seconds and then the weight display will indicate “0.000g”. When tare such as aluminum sheets, etc., are to be used, place them on the sample dish and then press the  key.

Main Unit Key Operations	Display	Explanation of Operations
<p>② Place Sample on the Sample Dish (Example: 8.210g)</p> 		<p>Open the lamp cover (drying section) and load a sample onto the sample dish when the weight display indicates “0.000g”. Load the sample on the dish so that it is spread out as evenly as possible.</p>
<p>③ Begin Measurement</p> 		<p>Close the lamp cover (drying section) and press the  key once.</p> <p>The infrared lamp lights and the weight display (g) switches to the moisture content display (%).</p>
<p>④ Measurement Running Display</p>		<p>Once every thirty seconds the FD-610 measures the weight and determines the moisture content while automatically determining the tare.</p> <p>A  mark will blink for approximately 10 seconds while the unit is automatically determining the tare.</p>

Main Unit Key Operations	Display	Explanation of Operations
<p>⑤ Completing the Drying Operation</p> <div data-bbox="220 262 349 331" style="border: 1px solid black; padding: 5px; text-align: center; width: fit-content; margin: 10px auto;"> START • STOP </div> <p>(Or stopping drying using the time setting)</p>	<div data-bbox="459 197 756 281" style="border: 1px solid black; padding: 5px; text-align: center; margin-bottom: 10px;"> 110 0 12.3% °C MIN </div> <div data-bbox="459 295 756 379" style="border: 1px solid black; padding: 5px; text-align: center;"> *110 0 12.3% °C MIN </div>	<p>When the  key is pressed or the set time (20 minutes in this example) is reached, the rectangular indicator will blink for approximately 10 seconds at the percentage indicator (“%”) on the display and the unit will automatically determine the tare and then the final moisture content value will be calculated after the final weight measurement is made. Next the lamp will go out, the displayed value will be held in the display and the buzzer will sound for approximately 15 seconds. The Drying Stop indicator “* ” will be displayed in front of the drying temperature value.</p> <ul style="list-style-type: none"> • When the  key is used to stop drying the time required to obtain the final moisture content reading may differ depending on exactly when the key is pressed. • When the unit has been set in “00” or the Auto Measurement Mode a plus sign “+” is displayed in front of the time value and the time display shows the elapsed time from the beginning to the end of the drying process.
<p>⑥ Take a Sample</p>	 Caution	<p>Open the lamp cover and use the supplied pincet to remove the sample dish and dispose of the used sample.</p> <ul style="list-style-type: none"> • The sample dish and sample will be very hot when removed from the drying section. Be sure to use the pincet to remove the sample dish unit. • To continue making measurements, use another sample dish (a cool one). Also allow the unit to cool down for 1 or 2 minutes before beginning the next measurement.

Main Unit Key Operations	Display	Explanation of Operations
<p>⑦ Preparing for the Next Measurement</p> 		<p>Press the  key to make the next measurement. The display will return to its initial condition.</p>
<p>⑧ The Next Measurement</p>		<p>Repeat the procedure from step ② on page 23 to make further measurements.</p>
<p>⑨ Turn the Power Off</p>		<p>When all measurements have been completed, turn the power switch to the off position. Also be sure to turn the power off whenever the tester is not in use.</p>

8. Notes Regarding Measurement

1. Provide power supply a directly as possible from electrical outlet.

Power supply voltage fluctuations can affect the drying temperature and measured water content value. It is therefore recommended that you avoid using table taps, etc., and provide the unit with a power supply from a stable electrical outlet, etc., as directly as possible.

2. Warm up the FD-610 for improved measurement precision.

When using the FD-610 for the first time or when the unit has not been used for a long period of time, it is recommended that you first warm up the unit by performing the measurement procedure for approximately 10 minutes without loading an actual sample.

3. Avoid wind.

At times the unit may be subjected to unexpectedly strong winds from air conditioners, etc. Although the FD-610 has been designed so as to minimize the effects of external disturbances, please avoid subjecting it to direct winds as they can adversely affect measurement precision.

4. Use two sample dishes alternately when making measurements one after another.

Placing samples on a sample dish which retains residual heat may cause some of the moisture in the sample to evaporate, thus leading to measurement errors.

When making one measurement after another, be sure to use a sample dish which has been allowed to cool down for each measurement.

Also allow the FD-610 unit itself to cool down for 1 to 2 minutes between measurements.

- Two sample dishes are supplied with the FD-610.

5. Place samples as evenly as possible on the sample dish.

If samples are piled on the sample dish in heaps, more time is required to dry the sample and in addition the top can be burnt and accurate measurement may not be possible.



6. If drying a material causes it to adhere to the sample dish, spread the supplied aluminum sheets in the sample dish first, then perform tare elimination before loading the sample and performing the measurement.

To avoid having samples adhere to the sample dish, spread the supplied aluminum sheets (20 sheets supplied), etc., in the sample dish before loading samples and then place samples on top of the sheet.

- The aluminum sheets cannot be re-used. Extra aluminum sheets are available as a separate product.

7. Grind large-grained samples to an appropriate size before making measurements.

A long time may be required to thoroughly dry samples if the sample grains are large, and in addition the sample surface may be burned, thus making accurate measurement impossible. Grind the grains down to a size which is appropriate to the material before making measurements.

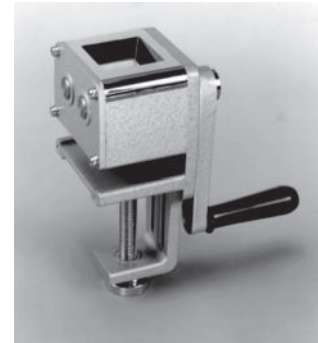

Model TQ-100 Sample Grinder

9. RS-232C Output

The specifications for the FD-610's RS-232C terminal used for connecting to the optional VZ-330 printer or a personal computer are indicated below.

1. Interface Specifications

- 1) Format : EIA RS-232C
- 2) Transmission Format : Asynchronous, transmission only
- 3) Signal Format : Baud Rate : 2400bps
 : Data Bit Length : 8 bits
 : Parity : None
 : Stop Bit : 1 bit
 : Code : ASCII

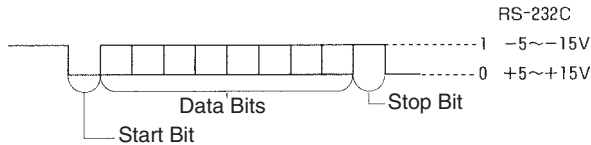

2. Connecting to the Optional VZ-330 Printer

Use the VZ-330's serial input connector to connect the printer to the FD-610.

3. FD-610 and RS-232C Cable Wiring

- 1) FD-610 — VZ-330 Printer
 (Special cable available)

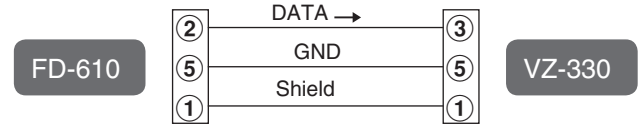

- 2) FD-610 — Personal Computer

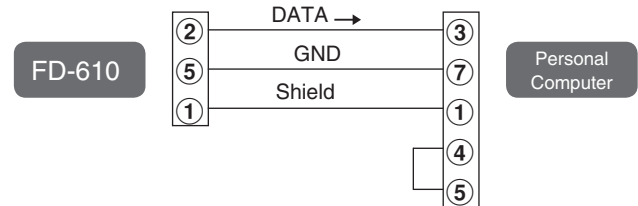

4. Sample Printer Output

Example : Drying temperature 140°C, Auto stop A, Sample weight 6.010g

SET TIME	SET TEMP	WET WEIGHT
A	140°C	6.010g

MIN	TEMP	MOIS
0	23°C	0.0%
1	52°C	0.2%
	83°C	0.9%
2	106°C	2.1%
	122°C	3.2%
3	135°C	5.2%
	141°C	7.2%
4	140°C	8.8%
	140°C	9.9%
5	141°C	10.7%
	140°C	11.3%
6	140°C	11.7%
	141°C	12.1%
7	139°C	12.4%
	140°C	12.7%
8	140°C	12.9%
	139°C	13.1%
9	141°C	13.2%
	140°C	13.4%
10	140°C	13.5%
	140°C	13.6%
*10	140°C	13.6%

Elapsed measuring time

Changes in drying temperature

Measured value (%)

The last measured value



10. Notes Regarding Use of the FD-610

1. This infrared moisture tester has a high temperature heat source! Please take care when handling it.

The drying section become very hot.

Be sure to touch only the handle when opening and closing the drying section. Also be sure not to place combustible or flammable materials near the unit.

2. Operate the control panel keys gently.

The control panel features soft-touch type sheet keys.

Only press the keys with your finger tips. Never use sharp objects such as ball-point pens, etc., to press the keys as doing so may result in damage to the unit.

3. Transporting the FD-610

The FD-610 is a high precision instrument. To avoid damage to the unit during transport or shipping, always pack it in the special Styrofoam and cardboard packaging in which it was originally shipped from the factory.

4. Ground Connection

Connect a ground wire to the ground terminal.

11. Maintenance

Replacing the fuse

A 0.5A fuse is installed in the FD-610 when the units are shipped from the factory. An extra fuse is also provided as an accessory. If for some reason the fuse should be blown during measurement, replace it with a new one as indicated below.

- Please contact Kett if the fuse should blow again after being replaced.

1) Removing the fuse

Insert a regular screwdriver (3ø diameter) into the square hole on the front of the fuse holder and lightly incline it upwards. The holder will be pushed out by a spring. Pull it out all the way.

2) Replacement

Insert a new fuse into the holder and then re-insert the holder back into the main unit.

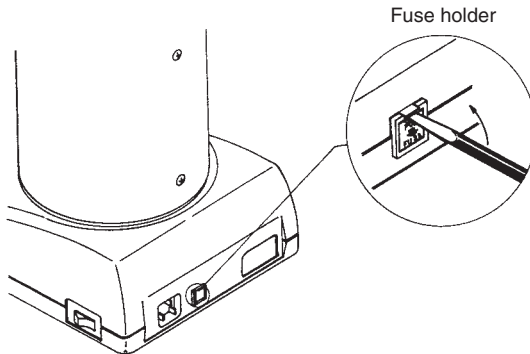

Appendix : Representative Drying Sample (Wheat flour)

Wheat flour (Drying temperature: 140°C, Time Measurement Mode (10 minutes), Sample weight: 6.175g)

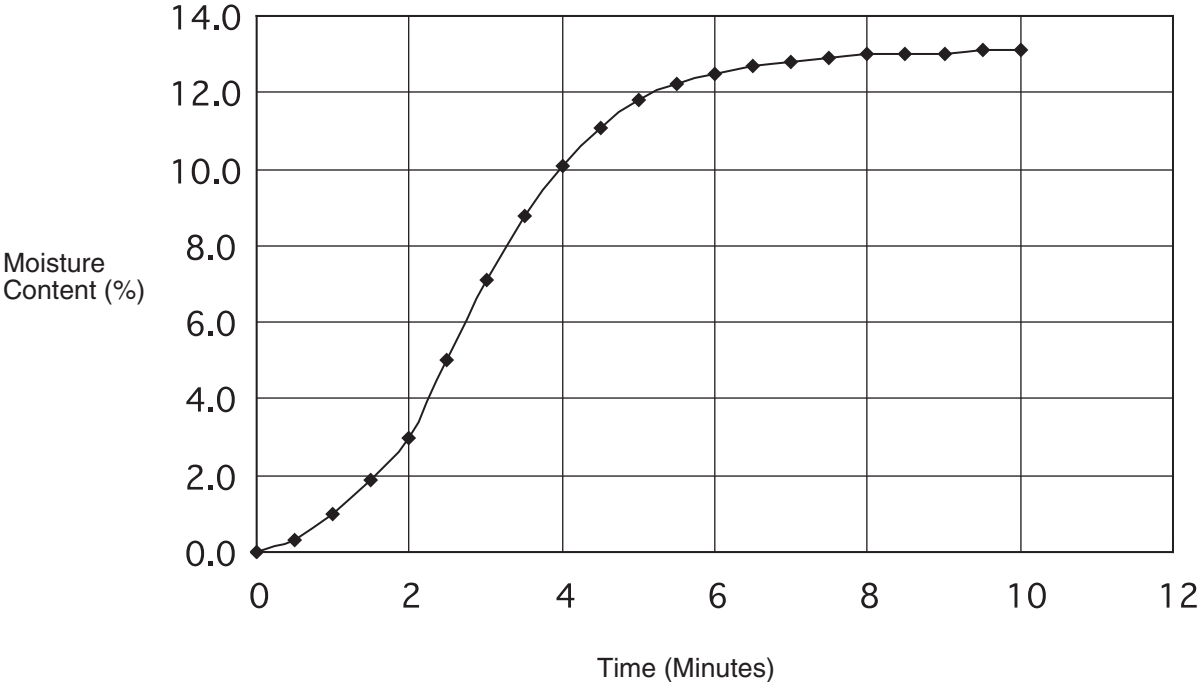

MEMO

MEMO

